

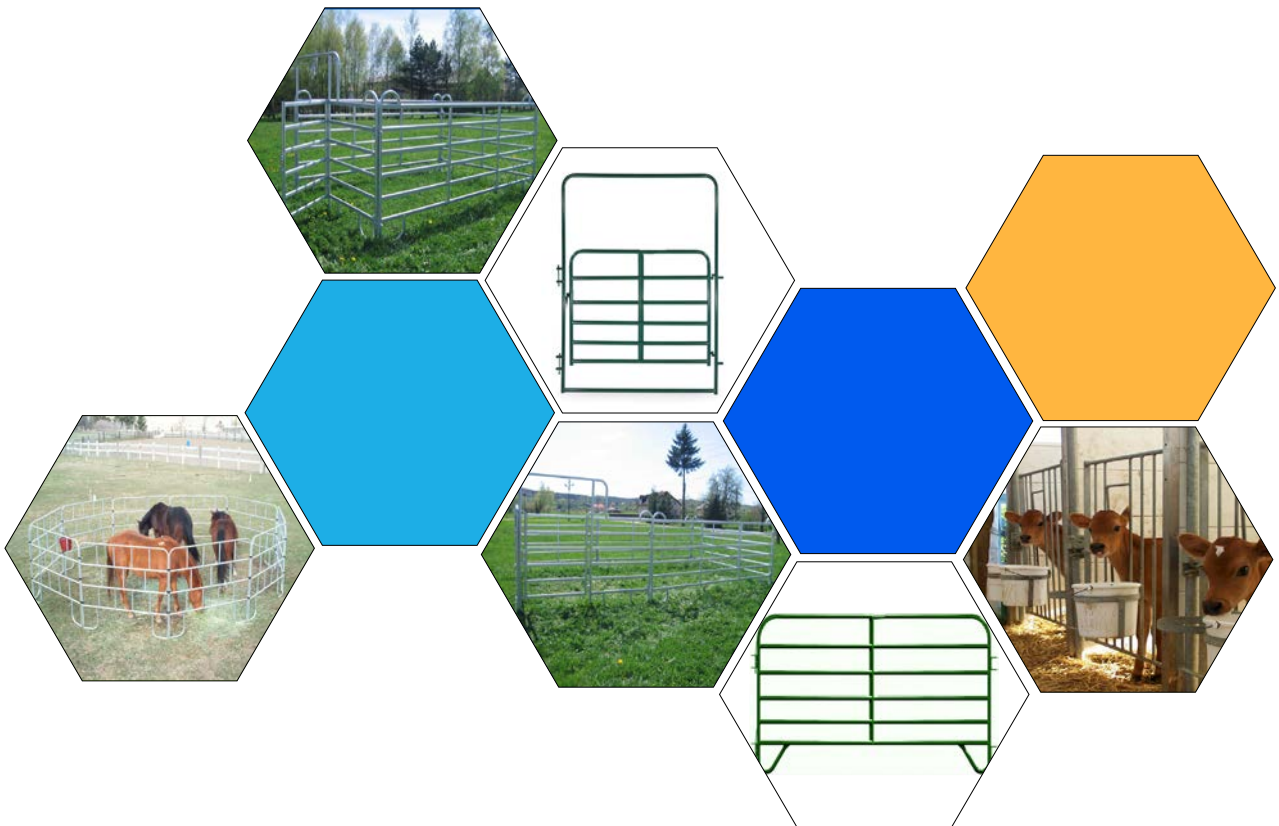

ANPING DB METAL FENCING CO., LTD.



HORSE FENCE PANEL

EASILY ASSEMBLED AND DISASSEMBLED

PORTABLE AND PERMANENT FENCING

SAFETY OF ANIMALS AND PEOPLE

UTILITY AND VERSATILITY

About Us

Horse fence panel is made of pipes to make sure horse safe and prevent other animals from being injured.

Horse fence panel can be used for rodeos, livestock and ranch, temporary round pens, equine activities and emergencies when camping or traveling.

Tian Guan company has been specialized in the production of horse fencing for about 20 years. The professional machine, advanced technology and rich experience make us produce high quality products and design new fencing for your horse based on your requirements.



Material of horse fence panel

Our horse fence panel, made of square, round or oval pipes is ideal for raising and protecting horse. The material of fence panel is carbon steel and the surface treatment is galvanized or PVC coating.

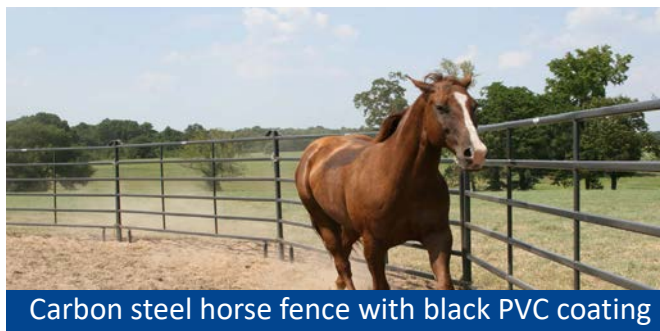

Carbon steel horse fence with black PVC coating



Carbon steel horse fence with galvanized finish

Horse fence panel's technical data

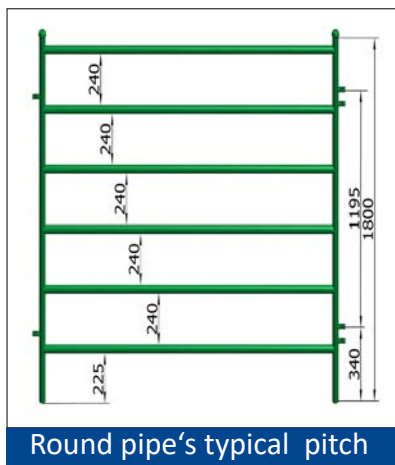

Round pipe's typical pitch

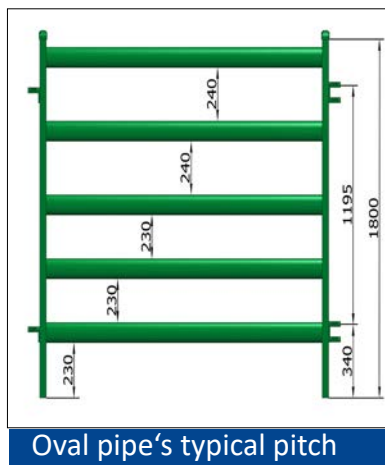

Oval pipe's typical pitch

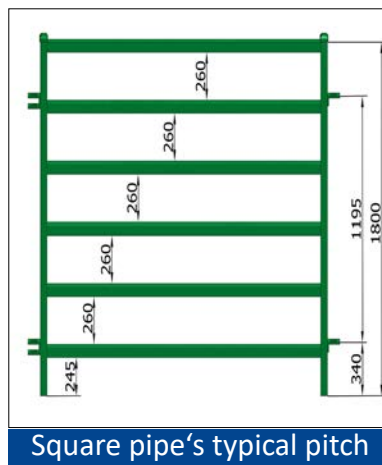

Square pipe's typical pitch

Pipe material	Pipe shape	Pipe diameter (mm)	Pipe thickness (mm)	Panel height (m)	Panel width (m)	Surface treatment	Weight (g/m ²)
Carbon steel	Round	32, 40, 42	1.5-2.5	1.5-2.0	1.5-2.4	Hot dipped galvanized	60-220
	Square	40 × 40, 50 × 50				Electro galvanized	7-20
	Oval	30 × 60				PVC spray paint	\

Feet types of horse fence panel

Horse fence panel's J shape feet and I shape feet are known to us. The J shape feet can prevent panels from sinking in soft ground. Thus, it can protect the pasture and earth well and allow panels to be slid when portability is required. The I shape feet is simple and fast to install make the panel quite flexible.



Galvanized fence panel with J shape feet



Red PVC coated panel with J shape feet



Galvanized fence panel with I shape feet



Yellow PVC coated panel with I shape feet

Surface treatment of horse fence panel

Horse fence panel has two kinds of surface treatment: galvanized and PVC coating. Galvanized panel is more anti-rust than PVC coating panel. While PVC coating panel is more optional in colors than galvanized panel. And available with architectural grade powder coat finish, our fence panel is scratching resistance and bad weather resistance.

PVC color: wheel white, barn red, forest green, saddle brown, gunmetal gray, etc.

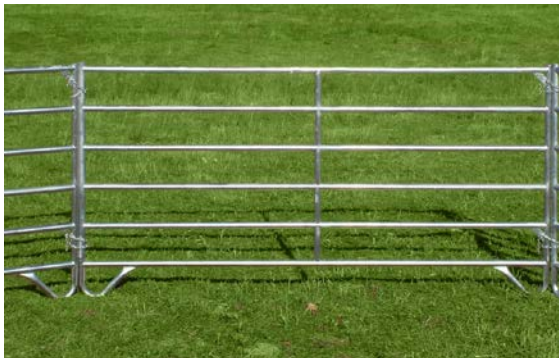

Hot dipped galvanized horse fence panel



Green PVC coated horse fence panel

Horse fence panel with gates

In addition to the production of various horse fence panels, we also can produce panel with gates. The gates that we produced commonly have three types: single swing gate, double swing gate and combined bow gate. All can be customized according to your special requirements.

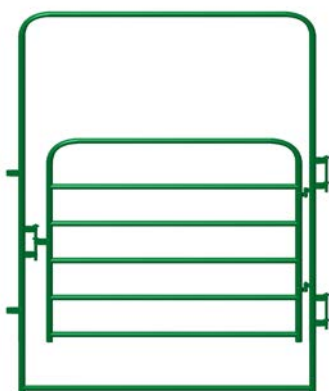

Combined bow gate

Panel length:	2.4 m, 3.0 m, 3.6 m.
Panel height:	1.2-1.8 m.
Pipe diameter:	15-50 mm.
Gate size:	(H)1.2-3.6 m, (W)1.2-3.6 m.
Surface treatment:	hot dipped galvanized or PVC coating.

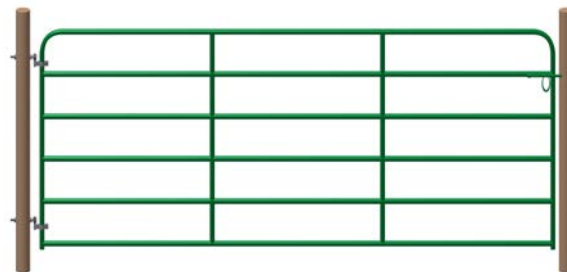

Single swing gate

Pipe diameter:	15-48 mm.
Pipe thickness:	1.2-2.5 mm.
Panel length:	1.2-6 m.
Panel width:	1.2-3.0 m.
Surface treatment:	hot dipped galvanized or PVC coating.



Double swing gate

Pipe diameter:	15-48 mm.
Pipe thickness:	1.5-2.5 mm.
Panel length:	1.2-6.0 m.
Panel width:	1.2-3.0 m.
Surface treatment:	hot dipped galvanized or PVC coating.

Combined bow gate types

1. Sealed ends by welding caps to the top and bottom of rails to prevent moisture leaking into the panel and enhance appearance.

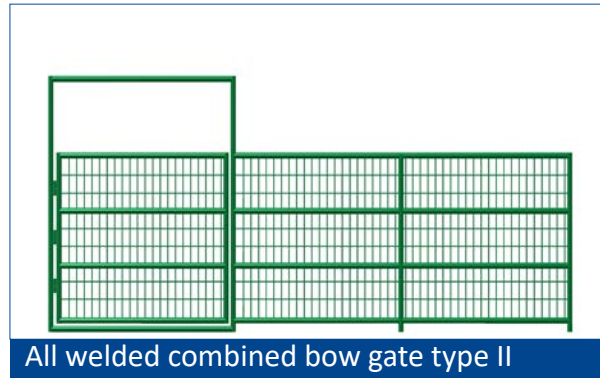
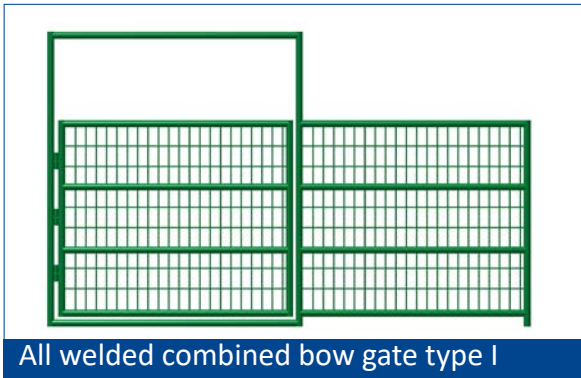

2. Livestock fence panels are ideal for keeping your livestock in and predators out.

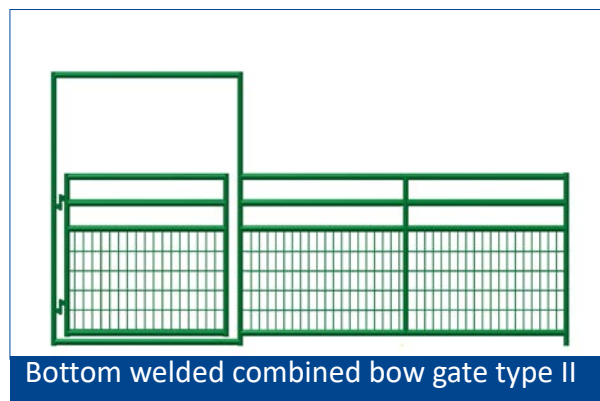
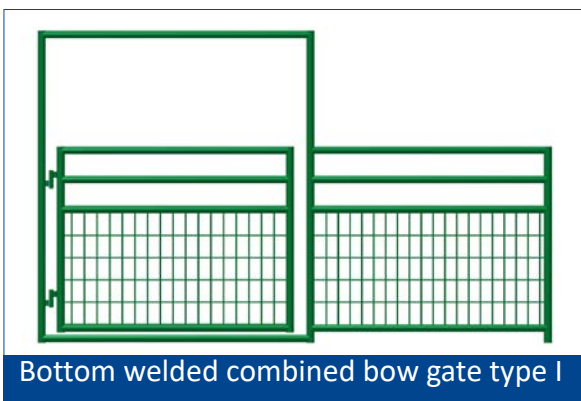

3. Double bow frame type is recommended to ensure its strength.

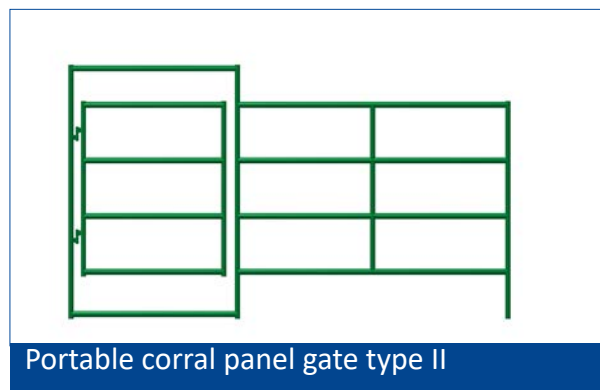
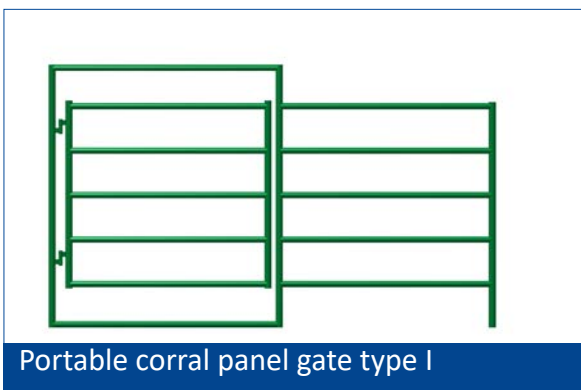

Raising type horse fence panel

In addition to the traditional horse fence panel, modular equine feed fence is also available. Modular equine feed fence can avoid the horse crashing when eating. This style fence provides the free eating spacing for horses or cattle, so it can be the most efficient and safest eating place for the horse and easy to handle.



Feed fence gate used for horse raising



Welded safe horse fence protects the pasture



Modular equine feed fence used with wood wall



Oval pipe galvanized horse panel with feeding place

Typical applications

Our fence panel with durability and the aesthetic appeal of high-grade powder coat finish make our panel great for horse and cattle round pens, temporary enclosures, large fence pastures, also suitable for arenas.



Installation

Six connecting methods



Accessories:
double lugs, single lug, pin.
Connecting way:
Lugs are connected by pin.



Accessories:
heavy duty bullet style triple latch and long rod.
Connecting way:
Combine the two panels and then put the long rod into the intermediate pipe.



Accessories:
steel panel clamp.
Connecting way:
Connect the two posts of the panels by steel panel clamp.



Accessories:
welded I-shaped hinge.
Connecting way:
Three-way pins are connected by I-shape hinge.



Accessories:
chain hookups.
Connecting way:
Galvanized panel connected by chain hookups.



Accessories:
three way triple hookup.
Connecting way:
Three-way pins are connected by triple hookup.

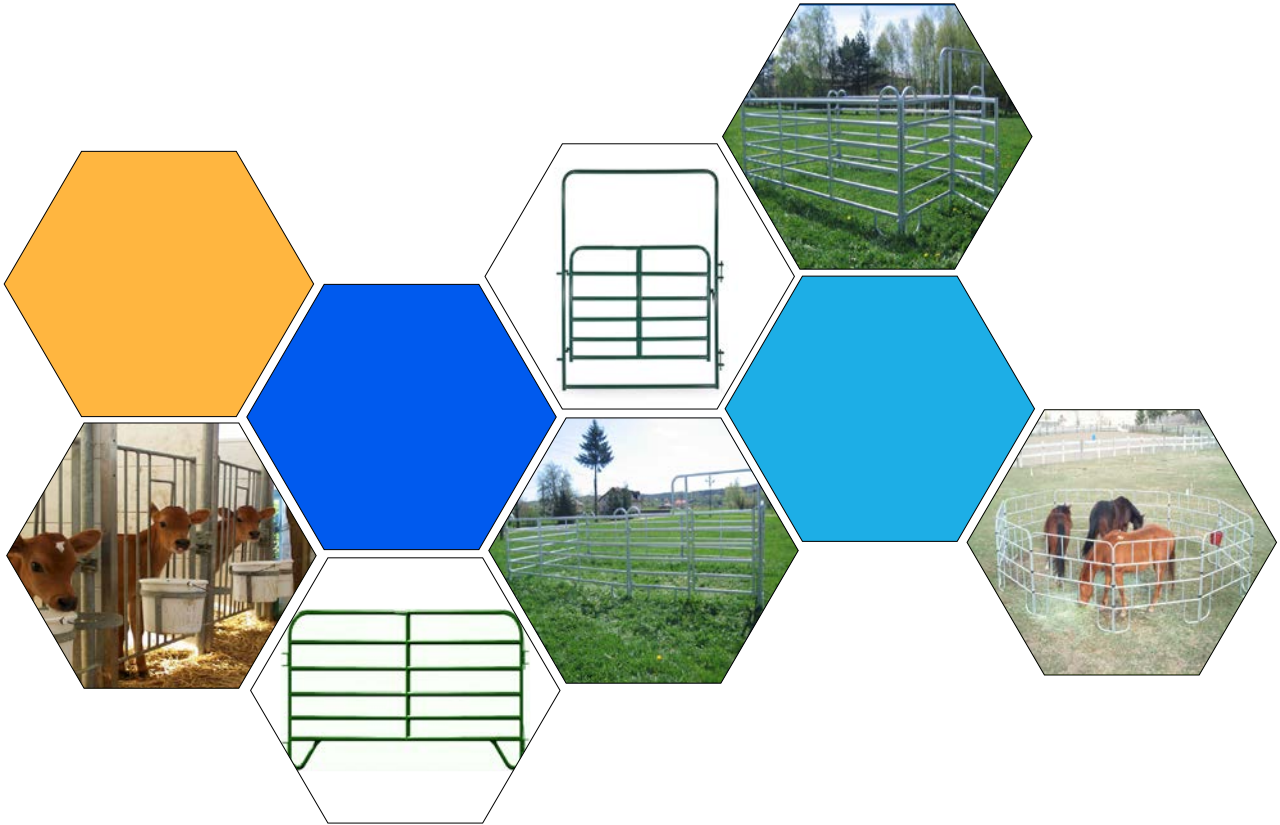

ANPING DB METAL FENCING CO., LTD.

Add: Wire industrial zone, Anping City, Hebei Province, China

Mobile: +86-13653185321

TEL: +86-318-7999123

FAX: +86-318-7999122

Website: www.horsefencing.org

E-mail: sales@corralpanels.org